

Split Core Hall Effect AC/DC Current Sensor CYHCS-LY05F

The sensor CYHCS-LY05F is a Split Core Hall Effect Sensor for the measurement of AC/DC current. The sensor has a galvanic isolation between the high power primary and the secondary electronic circuits with voltage output.

Features and Advantages	Applications
<ul style="list-style-type: none"> AC/DC current measurement Output signal option (4-20mA, 0-5V, $\pm 5V$) High isolation between primary and secondary circuits No insertion losses Split Core, easy installation Temperature compensation 	<ul style="list-style-type: none"> Photovoltaic equipment Battery banks, such as, monitoring load current and charge current, verifying operation Transportation, measuring traction power or auxiliary loads Phase fired controlled heaters Directly connect to PLC Sense motor stalls and short circuits Industrial instrumentation

Specifications

Rated input current (DC current calibration)	1000A	1500A	2000A	2500A
Linear measuring range	0~ $\pm 1200A$	0~ $\pm 1800A$	0~ $\pm 2400A$	0~ $\pm 3000A$
Overload current capability	20 times of rated input current, 5sec			
Output signals	$\pm 5VAC/DC$, 0-5VDC, 4-20mADC			
Power supply (voltage Ripple)	+12V DC, +24V DC, $\pm 12V DC$, $\pm 15V DC$ (5%)			
Measuring accuracy	$\pm 1.0\%$			
Linearity (10% - 100%), 25°C	$\leq \pm 1.0\% FS$			
Zero offset voltage	$\pm 50mV$			
Thermal drift of offset voltage	$\leq \pm 0.025\%/^{\circ}C$			
Galvanic isolation	6 kV DC, 50Hz, 1min			
Isolation resistance	$\geq 100M\Omega$			
Response time	$\leq 3\mu s$ for tracing output, $\leq 100ms$ DC voltage output, $\leq 150ms$ DC current output,			
di/dt following accuracy	50A/ μs			
Static current consumption	$\leq 50mA$			
Output load	Voltage output : $\geq 2k\Omega$, Current output: $\leq 250\Omega$			
Frequency range	DC ~ 10kHz			
Case style and Window size	LY05F , 122 x 22 mm			
Operating temperature	-25°C ~ +70°C			
Storage temperature	-45°C ~ + 85°C			
Relative humidity	$\leq 90\%$			
MTBF	>50000h			
Unit weight	2kg			

Definition of Part number:

CYHCS	-	LY05F	-	m	-	x	n
-------	---	-------	---	---	---	---	---

(1) (2) (3) (4) (5)

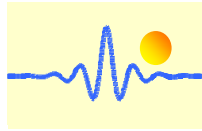

(1)	(2)	(3)	(4)	(5)
Series name	Case style	Rated Input current (m)	Output signal	Power supply
CYHCS	LY05F	m = 1000A, 1500A, 2000A, 2500A	x=1: tracing voltage $\pm 5V$ AC/DC x=3: 0-5V DC x=5: 4-20mA DC	n=2: +12V DC n=4: +24V DC n=5: $\pm 12V$ DC n=6: $\pm 15V$ DC

Example 1: CYHCS-LY05F-1000A -15, Hall Effect AC/DC Current sensor with
Output signal: tracing voltage $\pm 5V$ AC/DC
Power supply: $\pm 12V$ DC
Rated input current: 1000A AC/DC

Example 2: CYHCS-LY05F-1000A -14, Hall Effect AC/DC Current sensor with
Output signal: tracing voltage $\pm 5V$ AC/DC
Power supply: +24V DC
Rated input current: 1000A AC/DC

Example 3: CYHCS-LY05F-1000A -54, Hall Effect AC/DC Current sensor with
Output signal: 4-20mA DC
Power supply: +24V DC
Rated input current: 1000A AC/DC

DIMENSIONS (mm)

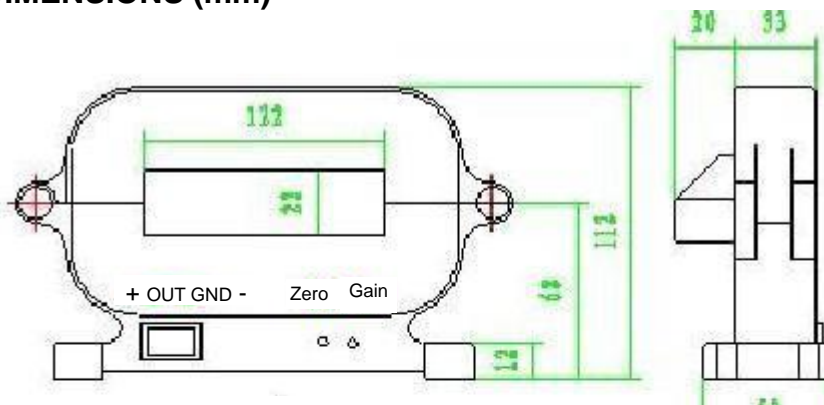

Pin Arrangement:

- +: V+
- : V- (or GND)
- OUT: Output
- GND: Ground

↑
A Direction

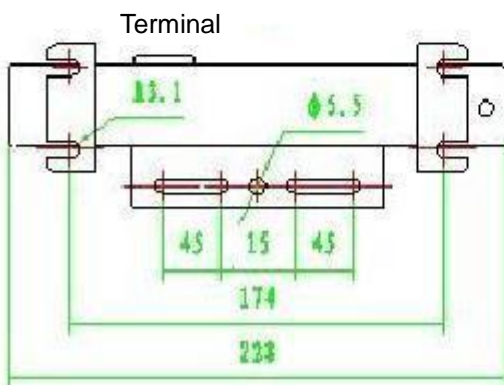

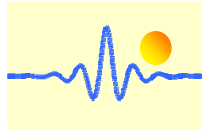

CONNECTIONS

The current carrying cable must pass through the window. The phase of output is the same as that of the current passing the window in the direction of the arrow indicated on the case.

a) Wiring of Sensors Using Double Power Supplies

Voltage Output

+: +15V/+12V
OUT: Output
GND: Ground
-: -15V/-12V

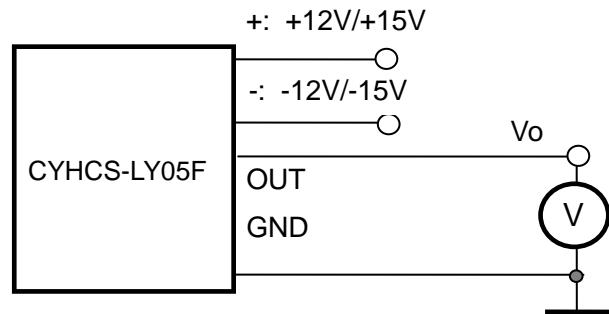

Relation between Input and Output:

Sensor CYHCS-LY05F-1000A-15	
Input current (A)	Output voltage (V)
-1000	-5
-500	-2.5
0	0
500	2.5
1000	5

Current Output

+: +12V/+15V
OUT: Output
GND: Ground
-: -12V/-15V

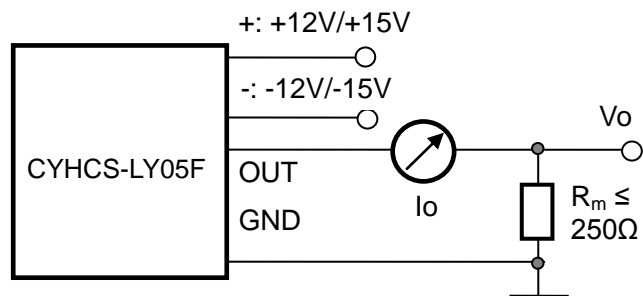

Relation between Input and Output (for $R_m=250 \Omega$):

Sensor CYHCS-LY05F-1000A-55		
Input current (A, RMS/DC)	Output current I_o (mA, DC)	Output voltage V_o (V, DC)
0	4	1
250	8	2
500	12	3
750	16	4
1000	20	5

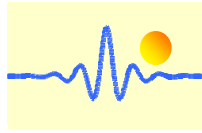

B) Wiring of Sensors Using Single Power Supply

Voltage Output

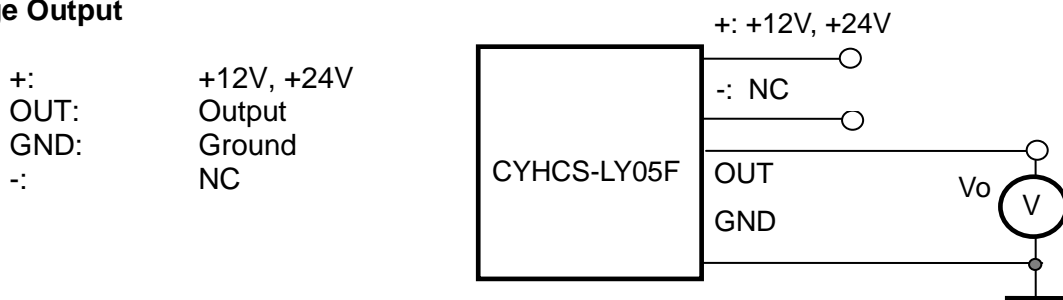

Relation between Input and Output:

Sensor CYHCS-LY05F-1000A-14	
Input current (A)	Output voltage (V)
-1000	-5
-500	-2.5
0	0
500	2.5
1000	5

Current Output

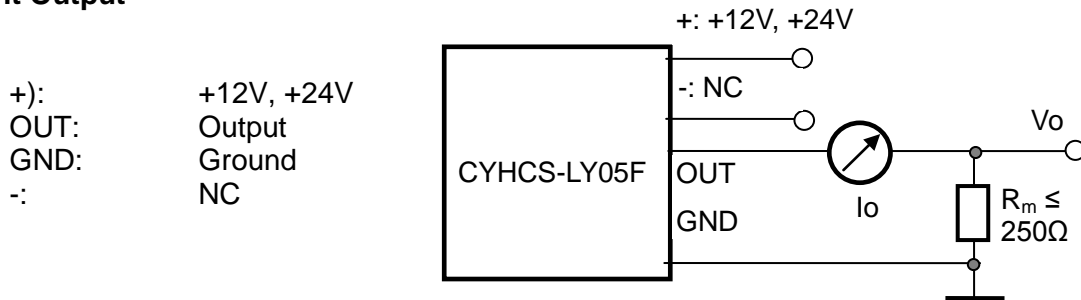

Relation between Input and Output (for $R_m=250 \Omega$):

Sensor CYHCS-LY05F-1000A-54		
Input current (A, RMS/DC)	Output current I_o (mA, DC)	Output voltage V_o (V, DC)
0	4	1
250	8	2
500	12	3
750	16	4
1000	20	5

Notes:

1. Connect the terminals of power source, outputs respectively and correctly, never make wrong connection.
2. Two potentiometers can be adjusted, only if necessary, by turning slowly to the required accuracy with a small screwdriver.
3. The best accuracy can be achieved when the window is fully filled with bus-bar (current carrying conductor).
4. The in-phase output can be obtained when the direction of current of current carrying conductor is the same as the direction of arrow marked on the transducer case.