

## CYSJ106A GaAs Hall Effect Element

CYSJ106A series Hall-effect element is a ion-implanted magnetic field sensor made of mono-crystal gallium arsenide (GaAs) semiconductor material group III-V using ion-implanted technology. It can convert a magnetic flux density signal linearly into voltage output.

### FEATURES

- High Linearity
- Superior Temperature Stability
- Miniature Package
- Wide measuring range 0-3T

### TYPICAL APPLICATION

- Magnetic Field Measurement
- DC Brushless Motor
- Current Sensor
- Non-contact Switch
- Position Control
- Detection Of Revolution

### BLOCK DIAGRAM

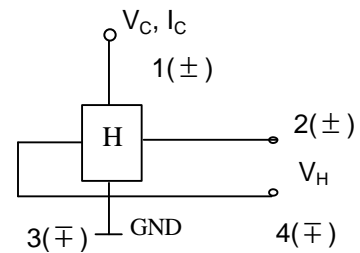

### ABSOLUTE MAXIMUM RATING

Parameter	Symbol	Value	Unit
Max. Input Current/Voltage	$V_C$	8	V
Max. Input Power	$P_D$	150	mW
Operating temperature range	$T_A$	-40~125	°C
Storage temperature range	$T_S$	-55~150	°C

### ELECTRICAL CHARACTERISTICS ( $T_A=25^\circ\text{C}$ )

Parameter	Symbol	Test conditions	Value	Unit
Hall output voltage	$V_H$	$B=100\text{mT}$ , $V_C=6\text{V}$	150~190	mV
Offset voltage	$V_{os}(V_u)$	$V_C=6\text{V}$ , $B=0\text{mT}$	$\pm 16$	mV
Input resistance	$R_{in}$	$B=0\text{mT}$ , $I_C=0.1\text{mA}$	450~750	$\Omega$
Output resistance	$R_{out}$	$B=0\text{mT}$ , $I_C=0.1\text{mA}$	1000~2000	$\Omega$
Temperature coefficient of Hall output voltage	$\alpha V_H$	$I_C=5\text{mA}$ , $B=100\text{mT}$ ( $T_a=25^\circ\text{C} \sim 125^\circ\text{C}$ )	-0.06	%/°C
Temperature coefficient of input and output resistance	$\alpha R_{in}$ $\alpha R_{out}$	$I_C=0.1\text{mA}$ , $B=0\text{mT}$ ( $T_a=25^\circ\text{C} \sim 125^\circ\text{C}$ )	0.3	%/°C
Linearity	$\Delta K_H$	$I_C=5\text{mA}$ $B=0.1/0.5\text{T}$	2	%

### Notes:

$$\alpha V_H = \frac{1}{V_H(T_1)} \times \frac{V_H(T_2) - V_H(T_1)}{T_2 - T_1} \times 100,$$

$$\Delta K_H = \frac{K(B_1) - K(B_2)}{[K(B_1) + K(B_2)]} \times 200$$

$$T_1=25^\circ\text{C}, T_2=125^\circ\text{C}, \quad B_1=0.5\text{T}, B_2=0.1\text{T}$$

$$\alpha R_{in} = \frac{1}{R_{in}(T_1)} \times \frac{R_{in}(T_2) - R_{in}(T_1)}{T_2 - T_1} \times 100$$

$$K_H = \frac{V_H}{I_C B}$$

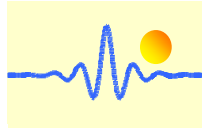

### Package Outline Drawing (Unit: mm)

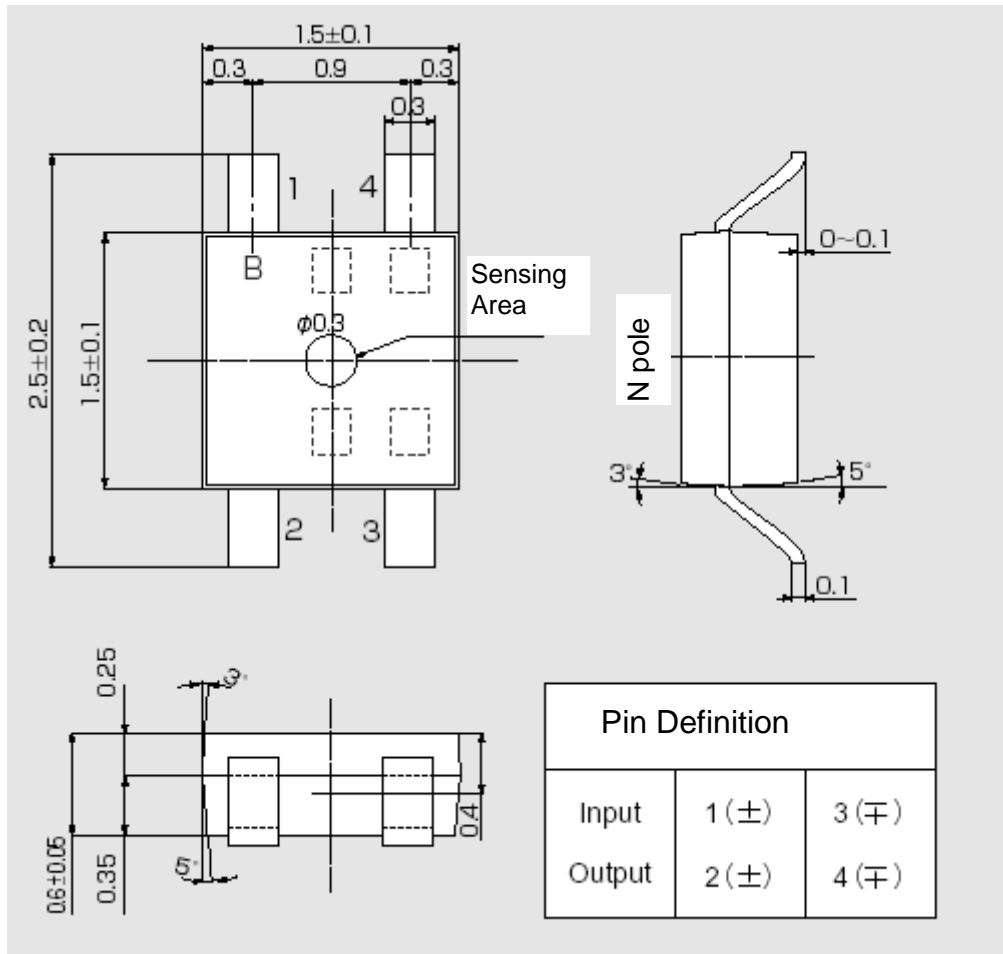

### Characteristic Curves

Allowable Package Power Dissipation

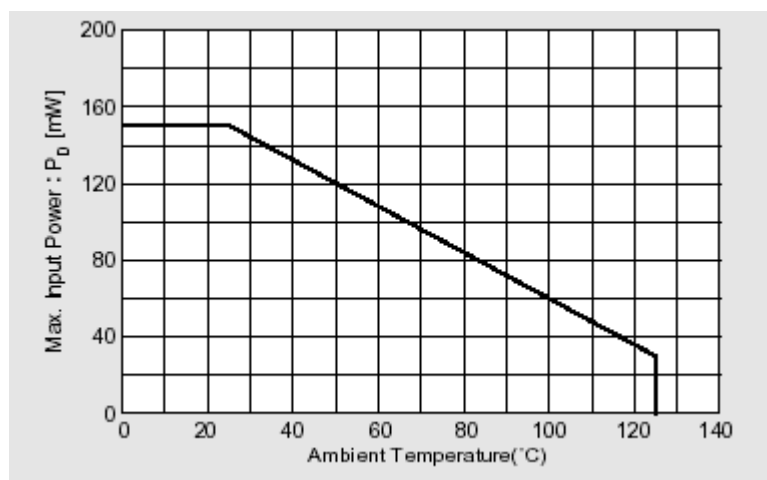

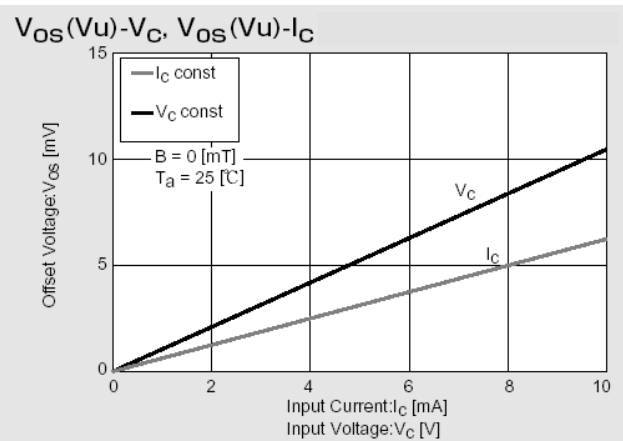
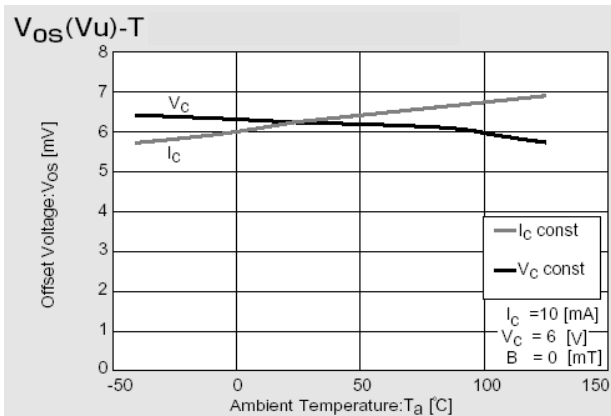
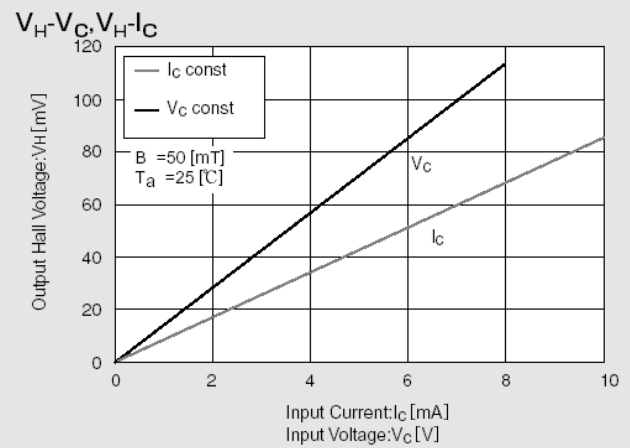
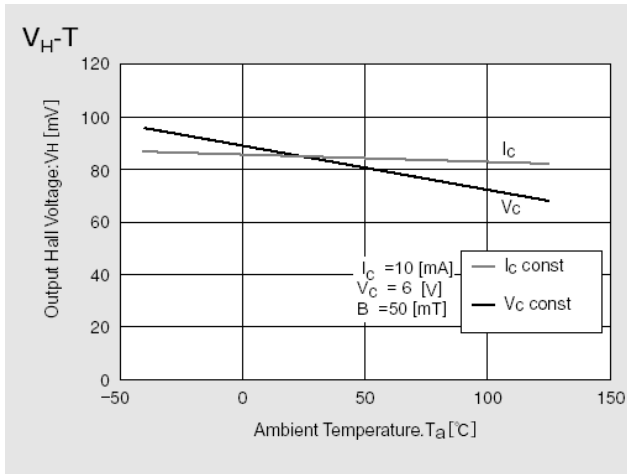
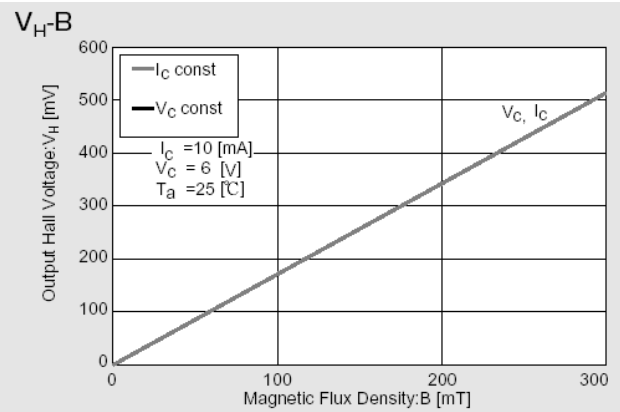
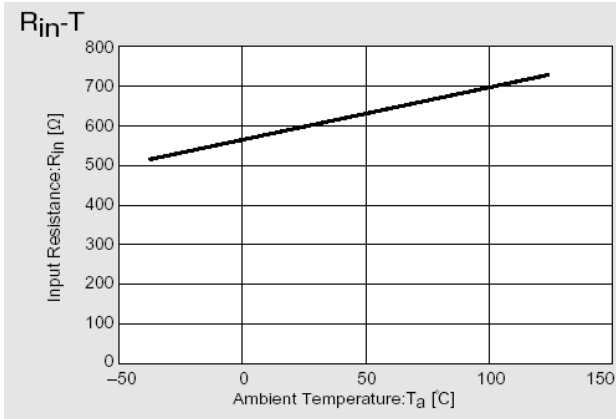
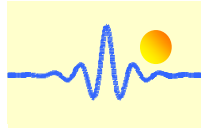

## Connection

Markt Schwabener Str. 8  
D-85464 Finsing  
Germany

Tel.: +49 (0)8121 – 2574100  
Fax: +49 (0)8121 – 2574101  
Email: [info@cy-sensors.com](mailto:info@cy-sensors.com)  
<http://www.cy-sensors.com>

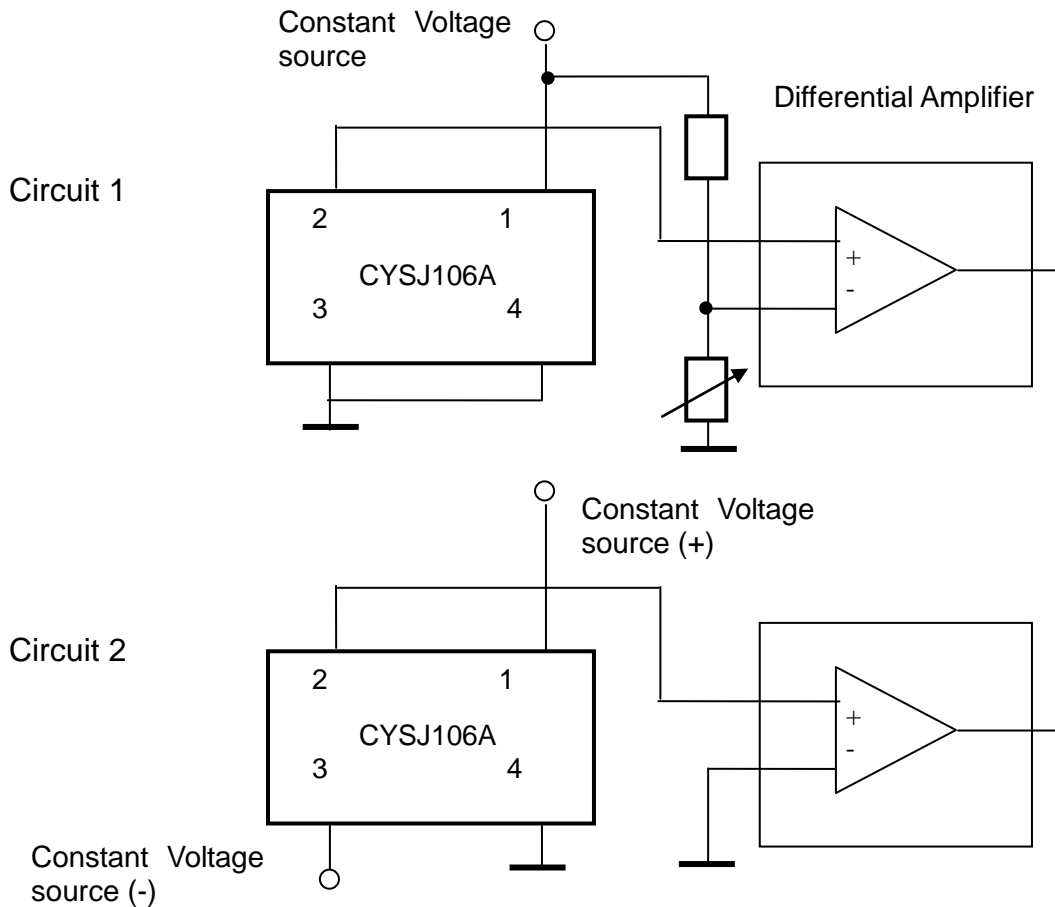
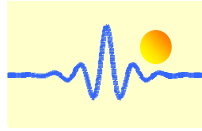

## Application Notes

The Hall voltage  $V_H$  can be positive and negative. But if one connects the sensor as follows (circuit 1):

Pin 1: positive input voltage  $V_+$ , for instance +5VDC.  
Pin 3: GND  
Pin 2: OUTPUT  
Pin 4: GND

One can only measure the positive voltage at the pin 2. This means that the output voltage at zero magnetic field is not zero. This voltage is called as offset voltage. The output voltage in this case is not equal to the Hall voltage. The output voltage is equal to the sum of offset voltage and Hall voltage.

The offset voltage will be zero if you connect double power supplies  $V_+$  and  $V_-$  to the sensor (circuit 2):

Pin 1: positive input voltage  $V_+$ , for instance +5VDC.  
Pin 3: negative input voltage  $V_-$ , for instance -5VDC  
Pin 2: OUTPUT  
Pin 4: GND

In this case the output voltage is equal to the Hall Voltage.